

IBOX™

BY **INCRA®**
OWNER'S MANUAL

Before using the **INCRA IBOX**, read and follow all of the instructions and safety information in this owner's manual.

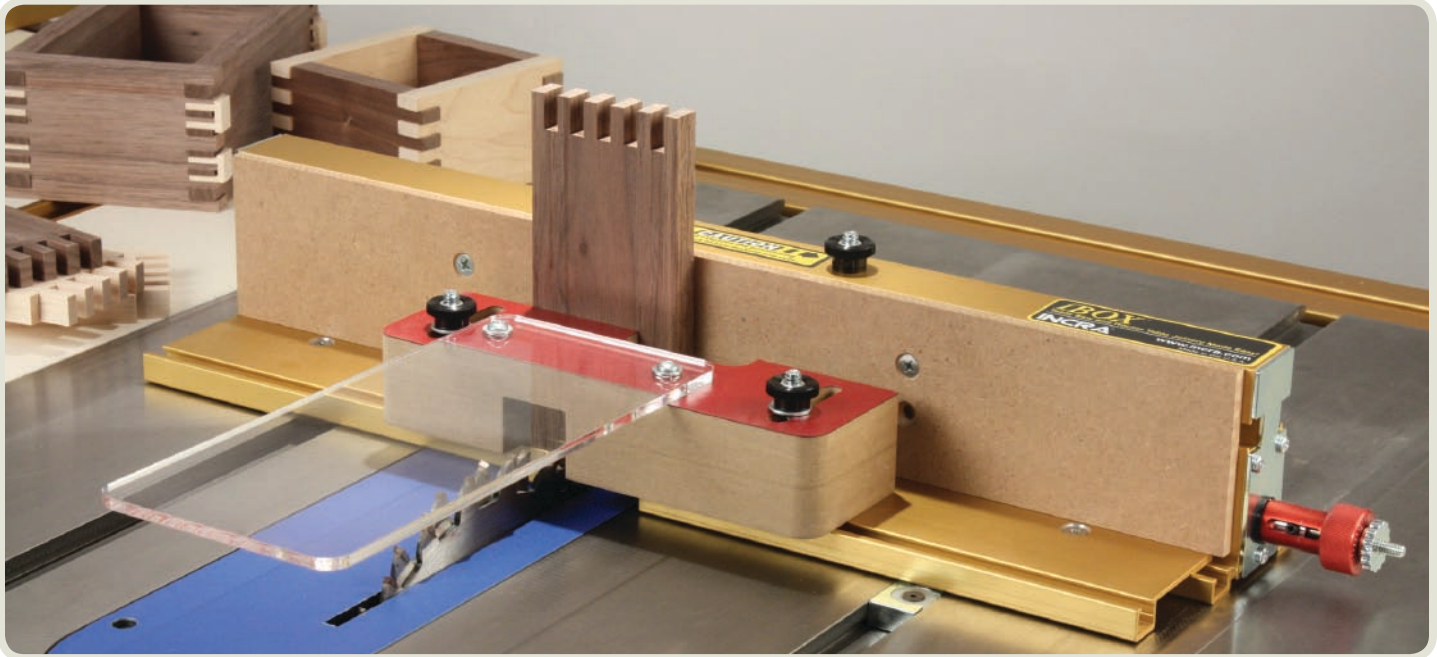

From delicate 1/8" fingers to bold 3/4" joints to exciting new box joint variations, your New INCRA IBOX is designed to provide the perfect resource for your next joinery task. The dual-pitch lead screw driven positioning engine controls both pin width and spacing with a single adjustment knob while INCRA's GlideLOCK™ adjustable miter bar provides smooth tracking at either your table saw or router table. Before using your New IBOX, please take the time to read this manual and be sure to watch the included DVD for some exciting new box joint techniques, tips and tricks.

CONTENTS	
○ Safety	1
○ Preliminary Setup	2
○ Setting up at the Table Saw	3
○ Setting up at the Router Table	4
○ Stock Ledges, Blade Guards & Backing Board	5
○ Operations – Cutting a Box Joint	7
○ Tips and Techniques	12

SAFETY Important safety instructions for using the **INCRA IBOX**

- Before using the INCRA IBOX, read and follow all instructions and safety information in this manual.
- When using the INCRA IBOX in conjunction with any other tool, first read and follow all instructions and safety information in that tool's owner's manual.
- Always turn off the power and make sure that the bit or blade is fully stationary before moving any part of the INCRA IBOX to any new setting.
- Always use a wooden handscrew clamp to secure your workpiece to the INCRA IBOX before making any cut.
- Before making a cut, always make sure that the blade guards are in place and that the fasteners that secure the stock ledges and blade guards are securely tightened.
- Wear safety glasses, hearing protection and follow all normal shop safety practices.
- When using the INCRA IBOX with other tools, make sure that all safety guards and other safety equipment supplied by the manufacturer of that tool are securely in place and functional. Never let the INCRA IBOX interfere with another tool's safety equipment.
- Keep hands safely clear of the bit or blade.
- DO NOT alter or modify the INCRA IBOX
- Do not attempt to use the INCRA IBOX with a "wobble" dado blade.
- Do not attempt to use the INCRA IBOX with any cutter smaller than 1/8".
- If using with a SawStop table saw, put the SawStop in the Bypass Mode before calibrating, adjusting, or checking blade clearances. Return it to normal operation before making a cut.

PRELIMINARY SETUP

Before beginning setup at the table saw or router table, make sure that the silver micro-adjust knob is adjusted so that the set screw in the slotted hole on the red knob is aligned approximately centered on the engraved line. This is the “home” position and while not every setup may require this “home” position, it is a good place to start when moving the IBOX to a new station. To reset, first loosen the black positioning lock knob located on the top of the IBOX. Hold the red knob in place as you rotate the silver micro-adjust knob until you see the set screw aligned as shown in **Detail IA**. While the black positioning lock knob is still loose, rotate the red knob to bring the (2) pin

plates together as shown in **Detail IB**. You'll see the pin plates located just inside the fence cutout. **After adjusting, tighten the black positioning lock knob, Fig. 1.**

Now let's get set up at your work station. If you are setting up at the table saw, read the “Setting up at the Table Saw” section that follows. For the router table, jump ahead to “Setting up at the Router Table” beginning on page 4.

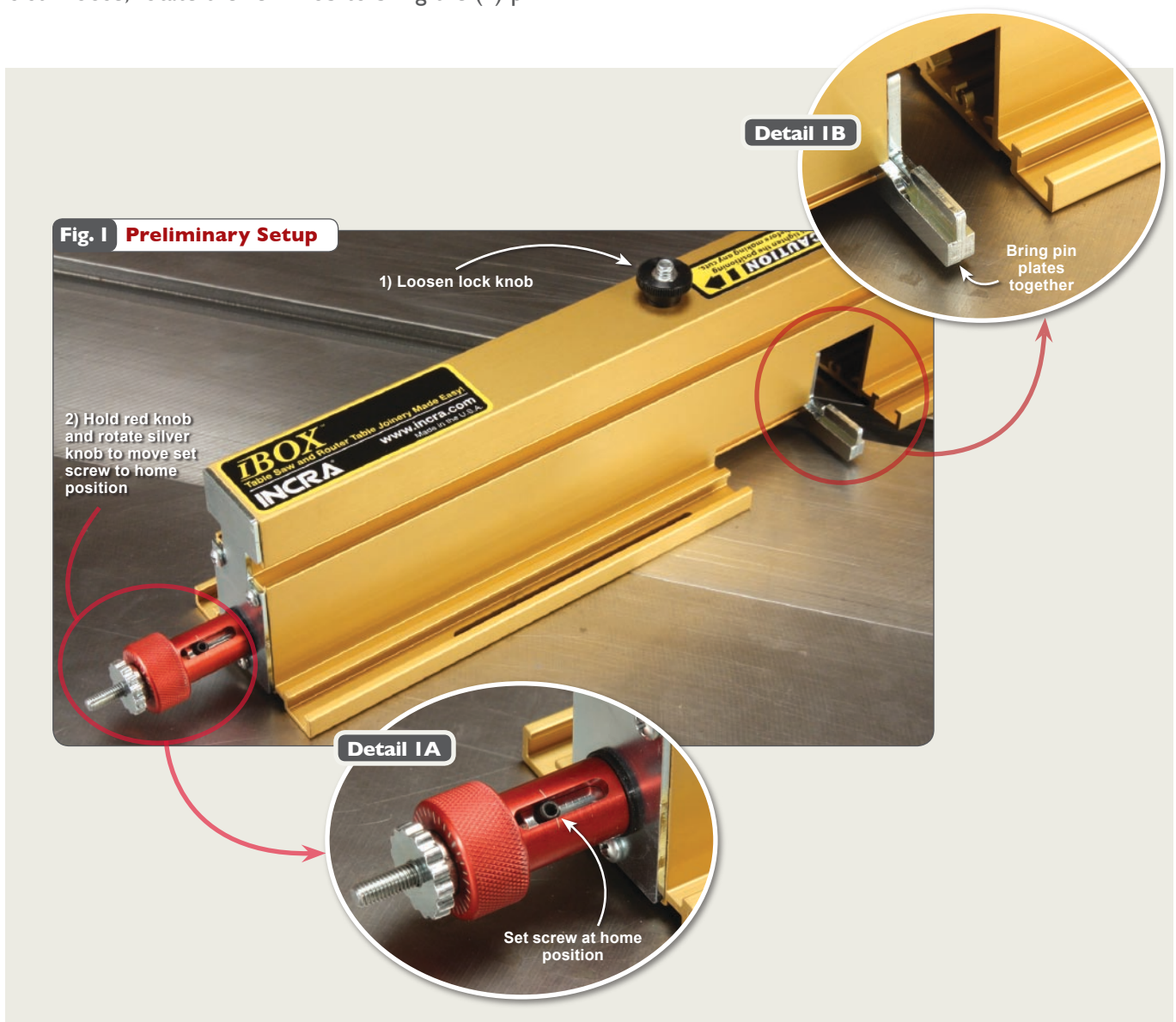

SETTING UP AT THE TABLE SAW

I. Install Stack Dado or Box Joint Blade of Choice

After completing the preliminary setup described on page 2, unplug your table saw and install your preferred box joint blade. The INCRA IBOX works with standard stack dado sets as well as 2-piece reversible blade box joint sets like those produced by Forrest, Ridge Carbide and Freud. You can cut delicate 1/8" box joints using standard 1/8" kerf table saw blades, but you'll want to choose a blade that features a flat ground raker tooth or a special box joint grind like those from Forrest and Ridge Carbide, **Fig 2**.

If you are setting up one of the reversible blade sets, begin with the widest cut profile for the setup that follows. You can change back to a narrow cut blade configuration later after the setup is complete. If you are setting up with a standard stack dado set, any cut width can be used during setup.

2. Adjust GlideLOCK™ Miter Bar Assembly

Drop the GlideLOCK™ Miter Bar Assembly into your table saw's miter slot. Use the left-hand slot for left tilting saws or the right-hand slot for right tilting saws. Now adjust the GlideLOCK™ expansion discs at each end of the bar to adjust the fit for a smooth glide in your table saw's miter slot. Turn the fasteners clockwise to make the glide tighter or counter-clockwise for a looser glide, **Fig. 3**. The alignment plate is factory squared but can be adjusted as required by loosening the (2) button head fasteners.



Fig. 2 Blade Types



Standard Stack Dado Set



2-Piece Reversible Blade Box Joint Set

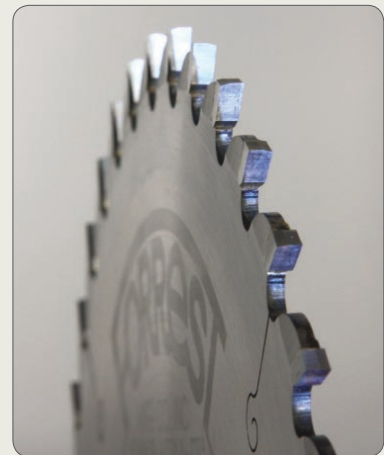

Special Grind Box Joint Blade

3. Attach IBOX to GlideLOCK™ Miter Bar Assembly

Position the IBOX fence on the GlideLOCK™ Miter Bar Assembly with the red knob on the left end for left tilting saws or on the right end for right tilting saws. Insert the (2) #10-24 x 3/8" button head fasteners through the slotted holes in the fence and thread into the holes on the GlideLOCK™ Miter Bar. Don't tighten the fasteners just yet. With your table saw unplugged, raise the dado up about 1/2" then slide the IBOX so that the cutter is inside the tall notch in the fence. Carefully slide the IBOX to the left or right until the blade "kisses" the steel pin plates on the IBOX, **Fig. 4 and Detail 4A**. Make sure that

the IBOX is firmly in contact with the alignment plate on the GlideLOCK™ assembly then tighten the (2) button head fasteners to secure the fence to the bar. Lower the blade. **NOTE: If you later move the IBOX to another table saw or your router table, you will need to reset the miter bar's position as described in steps 1-3 above for the table saw or as described in steps 1-2 on page 4 for the router table.**

Continue by skipping ahead to the section titled "STOCK LEDGES, BLADE GUARDS AND BACKING BOARD" on page 5.

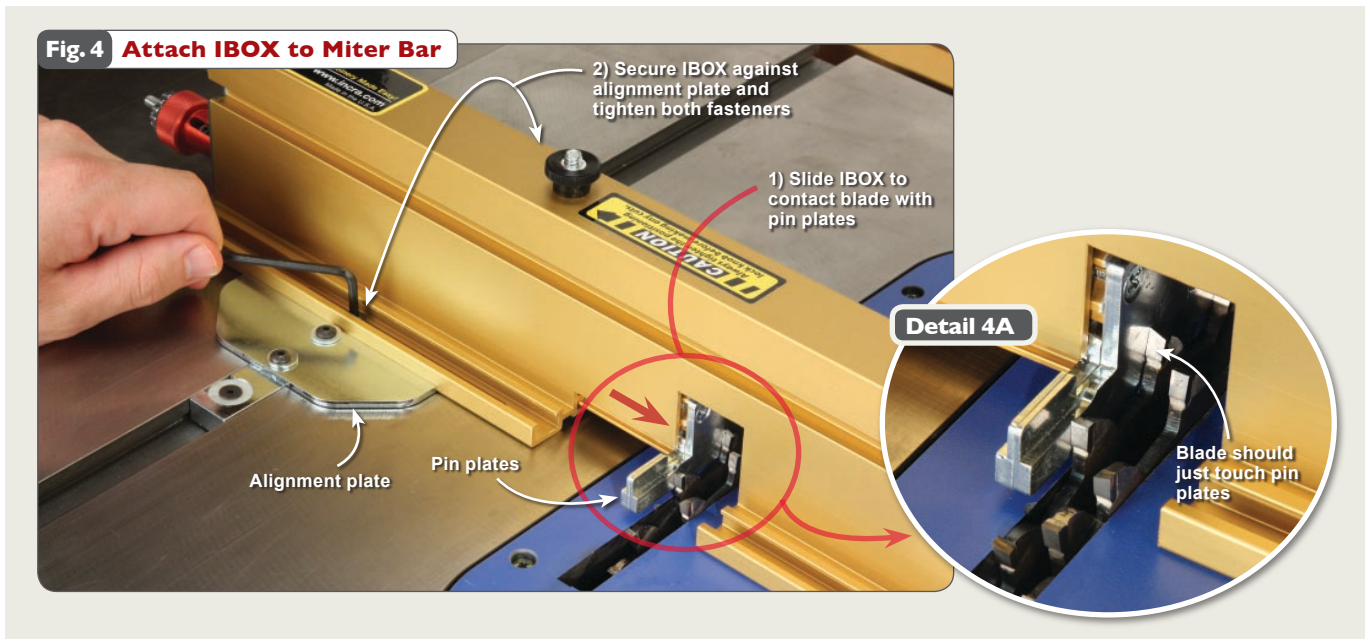

SETTING UP AT THE ROUTER TABLE

I. Adjust GlideLOCK™ Miter Bar Assembly

Drop the GlideLOCK™ Miter Bar Assembly into your router table's miter slot. Now adjust the GlideLOCK™ expansion discs at each end of the bar to adjust the fit for a smooth glide in your router table's miter slot. Turn the fasteners clockwise to make the glide tighter or counterclockwise for a looser glide, **Fig. 5**. The alignment plate is factory squared but can be re-adjusted as required by loosening the (2) button head fasteners.

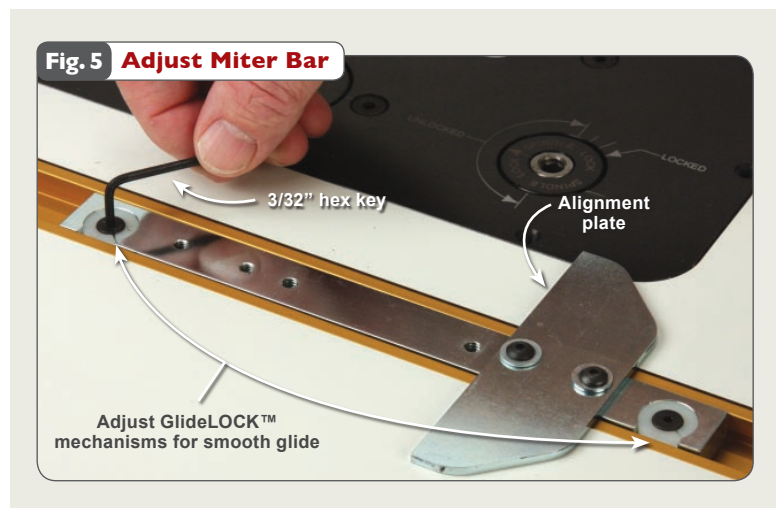

2. Attach IBOX to GlideLOCK™ Miter Bar Assembly

Position the IBOX fence on the GlideLOCK™ Miter Bar Assembly with the red knob on the **LEFT** end of the IBOX fence. Insert the (2) #10-24 x 3/8" button head fasteners through the slotted holes in the fence and thread into the holes on the GlideLOCK™ Miter Bar. Don't tighten the fasteners just yet. Slide the IBOX along the alignment plate until the tall notch on the fence is centered on your router's collet, **Fig. 6 and Detail 6A**. The center is 9/16" from the edge of the

notch if you would like to use a ruler for the alignment. Make sure that the IBOX is firmly in contact with the alignment plate on the GlideLOCK™ Miter Bar Assembly then tighten the (2) button head fasteners to secure the fence to the bar. If you move the IBOX to another router table or your table saw, you will need to reset the Miter Bar's position as described in Steps 1-2 above for the router table or steps 1-3 on page 3 for the table saw.

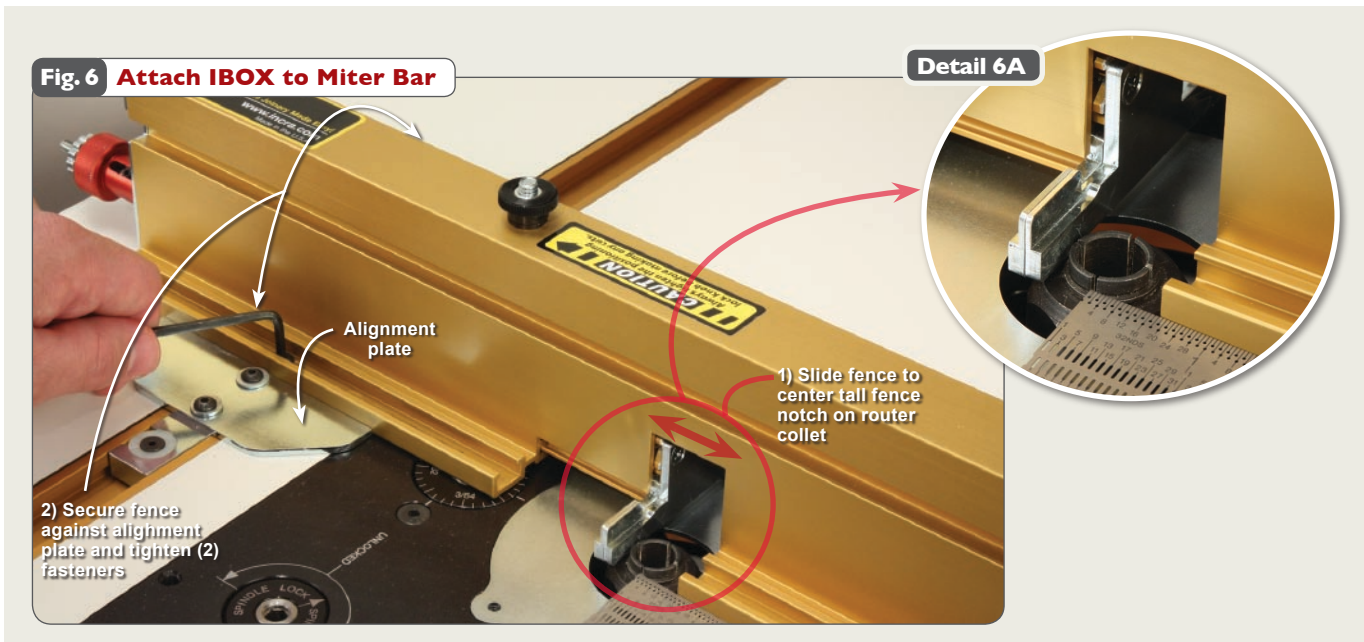

STOCK LEDGES, BLADE GUARDS & BACKING BOARD

In the following steps you'll add the Stock Ledges, the Blade Guards and the Backing Board. The photos show the table saw set up but the steps are identical for the router table.

I. Attach Stock Ledges

Insert the (2) #10-32 x 5/16" flat head Phillips screws through the countersunk holes in each stock ledge and loosely thread on the #10-32 rectangular nuts. The raised rim on the rectangular nuts should be facing the stock ledge. Slide the rectangular nuts into the T-slot on the front of the IBOX fence. For now, align the ends of the stock ledges with the wide cutout in the fence and tighten all (4) fasteners, **Fig. 7**.

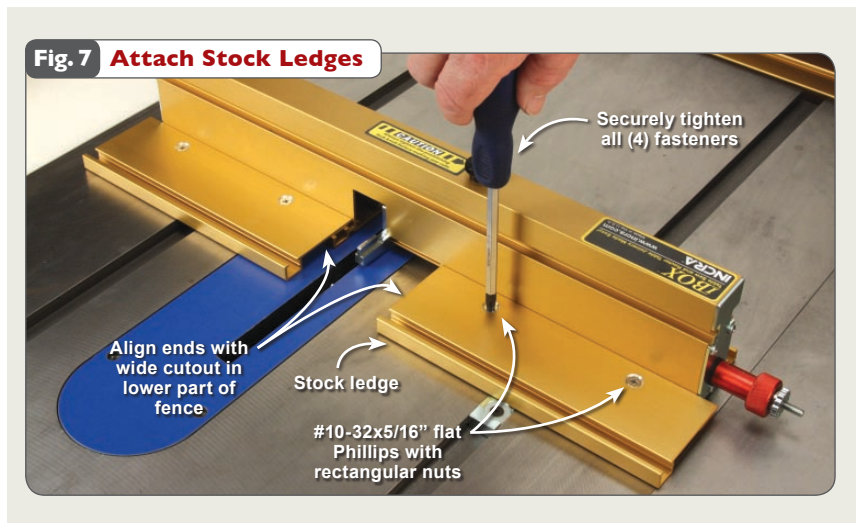

2. Attach Blade Guards

Before attaching the blade guards you'll need to identify the component positions. Turn the IBOX upside down and support it on a couple of 3/4" stock scraps. Hold the (2) blade guards with the square cut corners facing the fence so that the low and high cutouts in the guards match the low and high fence notches. The cutouts will only align one way, **Fig. 8**. Once you have identified which side each blade guard mounts to, use the included 1/4-20 x 2-1/4" hex bolts with washers and 1/4-20 thumb nuts to attach the guards to the T-slots on the fence and Stock Ledges. Before tightening the thumb nuts, make sure that the deep cutouts on the guards are aligned with the blade notch on the fence, **Fig. 9**.

3. Attach Backing Board & Deflector Shield

Insert (2) #10-32 x 1/2" flat head Phillips screws into the upper holes on the provided backing board. Thread on (2) #10-32 rectangular nuts then slide the nuts into the T-slot on the front face of the IBOX fence, **Fig. 10**. Center the backing board on the fence length and tighten the fasteners. The alternate holes on the backing board allow you to flip the board over when needed for a fresh backing surface. Using the (2) #8 x 1" pan head Phillips wood screws and #8 flat washers, attached the deflector shield to the front blade guard so that the deflector projects forward over the cutter. **Fig. 11** provides dimensions for making your own backing boards for future use.

Fig. 8 Identify Guard Components

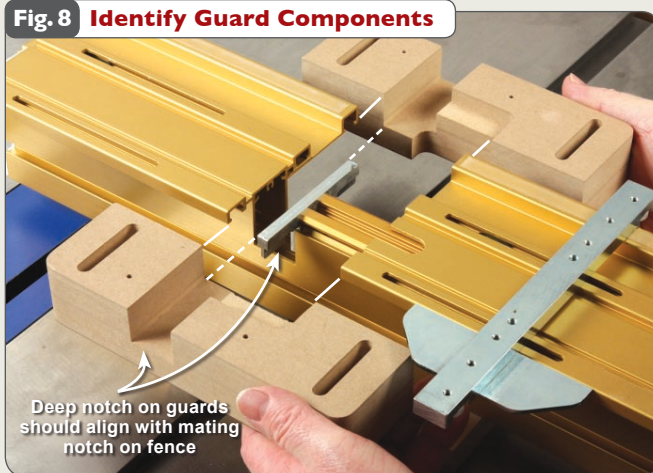

Fig. 9 Attach Blade Guards

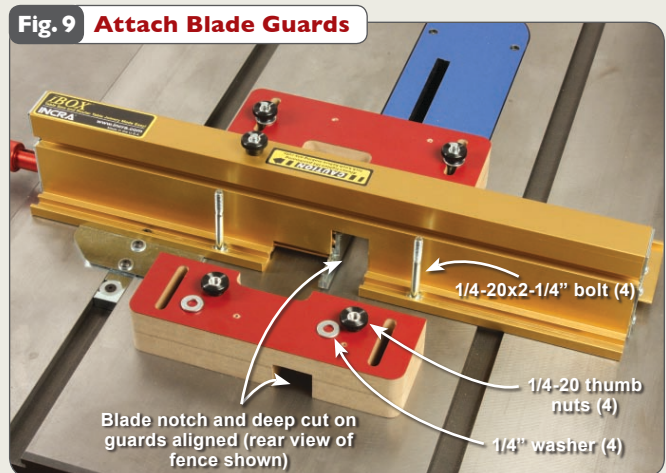

Fig. 10 Attach Backing Board and Deflector Shield

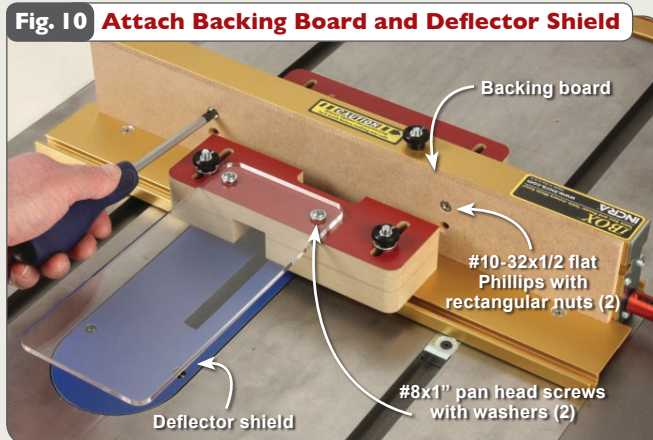
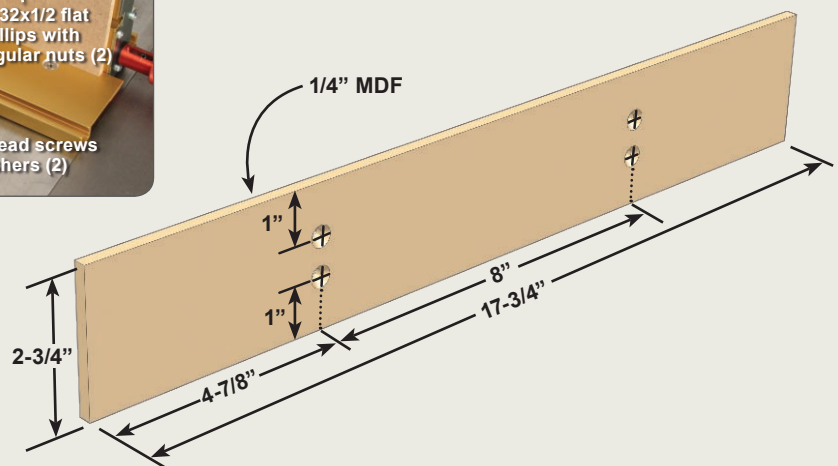

Fig. 11 Backing Board Dimensions



OPERATIONS – CUTTING A BOX JOINT

Whether you are cutting box joints at the table saw or the router table, the set up routines are the same. We'll detail the routines in this section with images from the table saw, but be sure to review the included DVD to see both stations in action.



GET READY...

1. Prepare Your Box-Making Stock

You'll want to begin by preparing your stock. You'll need one piece of scrap stock for a test cut. Mark one edge of all 4 of the box boards. We've used a Sharpie for clarity, but a pencil mark will work just fine, **Fig. 12**.

2. Install Your Cutter or Blade of Choice
UNPLUG YOUR TABLE SAW OR ROUTER TABLE and install the blade or cutter of choice. At the router table, a 2-flute standard straight bit will work fine. At your table saw you can use a standard stack dado, a reversible blade box joint set or a 1/8" blade with either a flat ground raker tooth or one of the custom ground box joint blades available, **Fig. 13**.

CAUTION:
DO NOT USE THE IBOX WITH WOBBLE DADO SETS OR THIN KERF 3/32" SAW BLADES!

3. Stock Ledges Apart, Pin Plates Together
 Bring the IBOX to your table. Loosen and slide the blade guard to the side for a clear view. Also loosen and slide both stock ledges away from the center of fence to provide clearance during setup. Double check to make sure that the pin plates are together. If you need to adjust the pin plates, loosen the positioning lock knob located on top of the fence and turn the red knob counterclockwise to bring the pin plates together, **Fig. 14 and Detail I4A**.

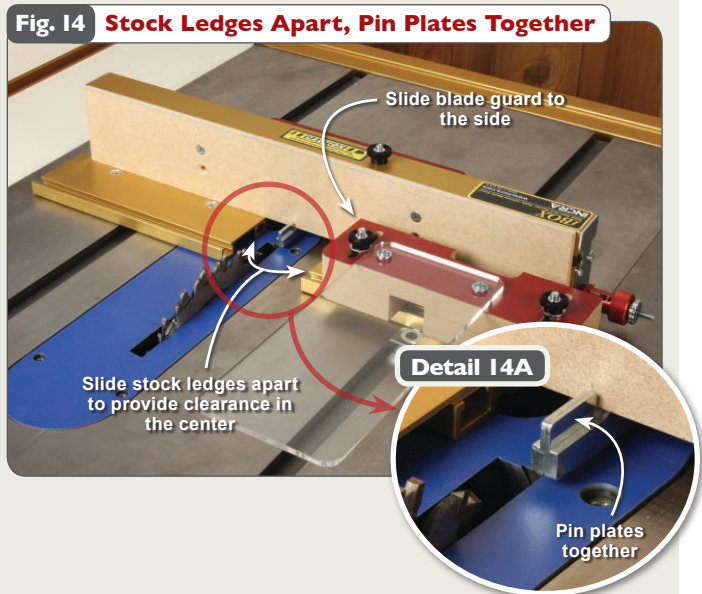
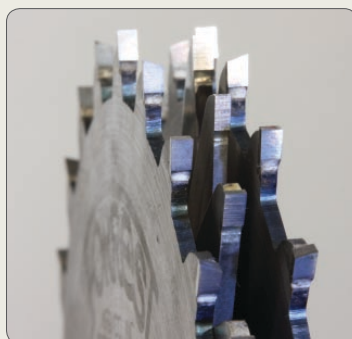
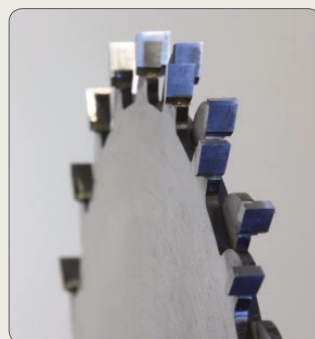

Fig. 13 Blade Types



Standard Stack Dado Set



Reversible Blade Box Joint Set



Special Grind Box Joint Blade



2-Flute Straight Bit

GET SET...

1. "Kiss" Calibrate

With the positioning lock knob loose, you need to "kiss" calibrate the IBOX (**YOUR TABLE SAW OR ROUTER TABLE SHOULD STILL BE UNPLUGGED**). To do this, slide the IBOX in your miter channel to a position adjacent to your cutter. Now hold the red knob as you rotate the silver micro-adjust knob to move the pin plates. You'll want the pin plates to just touch the blade, **Fig. 15 and Detail 15A**. If you are setting up at the router table, you may need to rotate the cutter by hand to confirm that the cutter just touches the pin plates. This "kiss" calibration step zeros the IBOX to the edge of your cutter. Subsequent adjustments to the pin plates made by turning the red knob will not alter this initial calibration.

2. Adjust Pin Plates for Test Cut

With the positioning lock knob still loose, rotate the red knob clockwise to move the nearest pin plate

about 1/8" or more away from the blade, **Fig. 16**. You'll notice that the pin plates will simultaneously move away from each other as they move away from the blade. This is OK. Your "kiss" calibration setting is automatically retained. **Tighten the black positioning lock knob located on top of the IBOX fence.**

3. Position Stock Ledges

Slide the blade side stock ledge to about 1/8" from the cutter then re-tighten the fasteners. **For reference, the blade side stock ledge refers to the stock ledge that is nearest to the cutter while the pin plate side stock ledge refers to the stock ledge that is on the other side of (and nearest to) the pin plates.** Slide the pin plate side stock ledge up to contact the pin plates and re-tighten the fasteners, **Fig. 17**. Slide the IBOX back and forth in the miter slot to make sure that the blade is clear of both the pin plates and the blade side stock ledge.

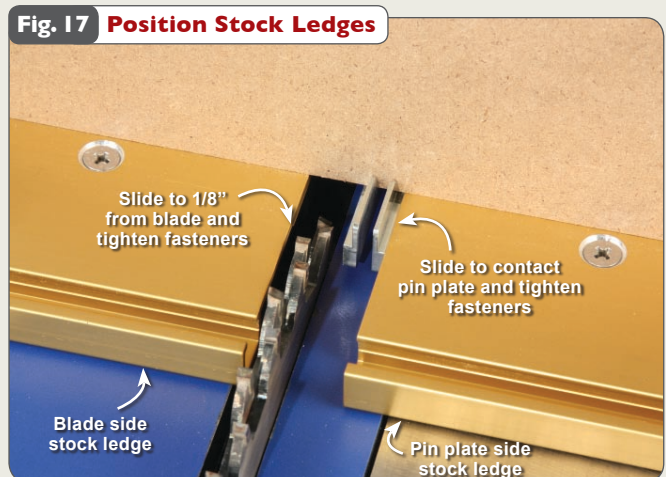
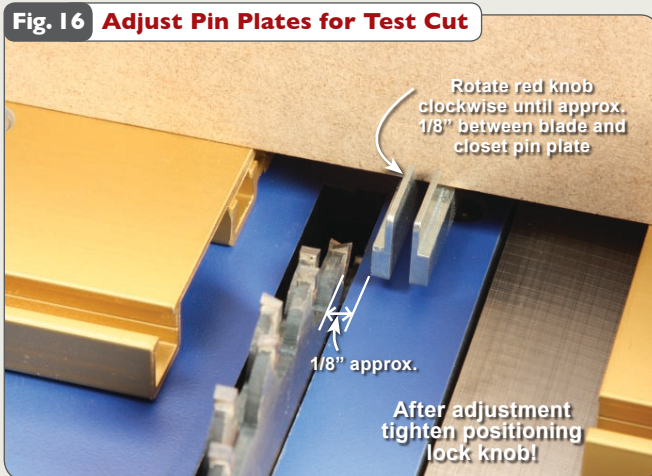
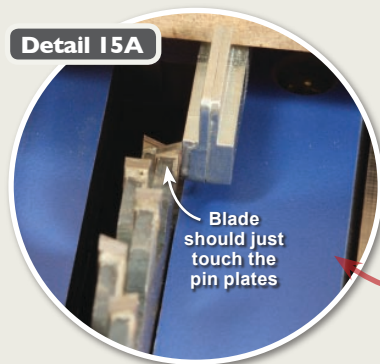

4. Set Depth of Cut

Set a piece of the wood prepared for your box on the stock ledge and raise your cutter to a depth of cut that will cut just slightly through your stock thickness, **Fig. 18**. This will produce pins that will protrude only slightly through the adjacent board when assembled. These slight protrusions can later be sanded flush. For a decorative look, the blade can be raised an additional 1/16" to 1/8" and the resulting "through" pins can be hand chamfered with a sanding block.

5. Position and Secure Blade Guard

Re-position the blade guard so that the view cutouts on the front and rear guards align. Sandwich your test cut board between the front blade guard and the fence then tighten the black thumb nuts to secure the guard, **Fig. 19**. The blade guard also functions as a vertical stock support, so apply light pressure to hold the blade guard against the stock as you tighten the thumb nuts.

6. Make a Test Cut

Stand your test cut piece on end on the blade side stock ledge between the fence and the blade guard and slide it up to contact the pin plates. Use a small wooden handscrew clamp as shown to clamp your

board to the fence as shown, **Fig. 20**. Plug in your table saw or router table then make a test cut. Turn off the motor after completing the cut.

7. Adjust Pin Plates to Fit Test Cut

Loosen the Phillips screws that secure the pin plate side stock ledge and either one of the thumbnuts that holds the blade guard. Loosen the positioning lock knob located on the top of the IBOX fence and rotate the red knob to open or close the pin plates until the test cut just made fits over the fingers on the pin plates (Both pins should be inside the test cut). You should feel a little friction when you raise or lower the board but you don't want it loose. You can view the pin plates as they are adjusted through the view cutout in the top of the blade guard, or you can simply slide the blade guard to the stock ledge on either side of the blade as shown, **Fig. 21**. **Tighten the positioning lock knob and the fasteners that secure the pin plate side stock ledge. If moved, re-position the blade guard and re-tighten the thumbnuts.** This pin plate adjustment automatically sets the required distance between the pins and the blade, so no further adjustments are required. Now let's make our box!

Fig. 18 Set Depth of Cut

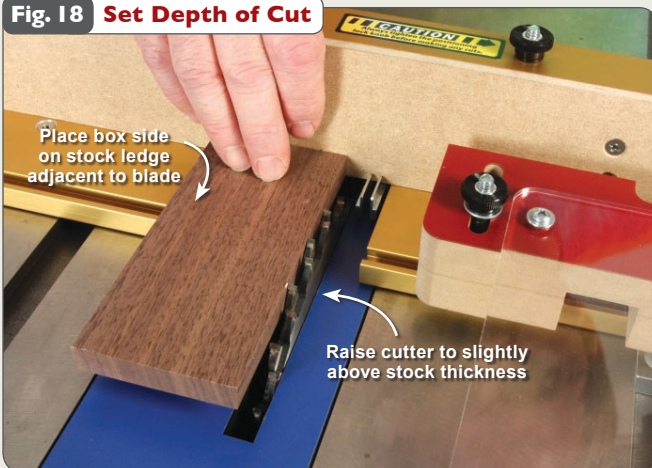

Fig. 19 Position and Secure Blade Guard



Fig. 20 Make Test Cut

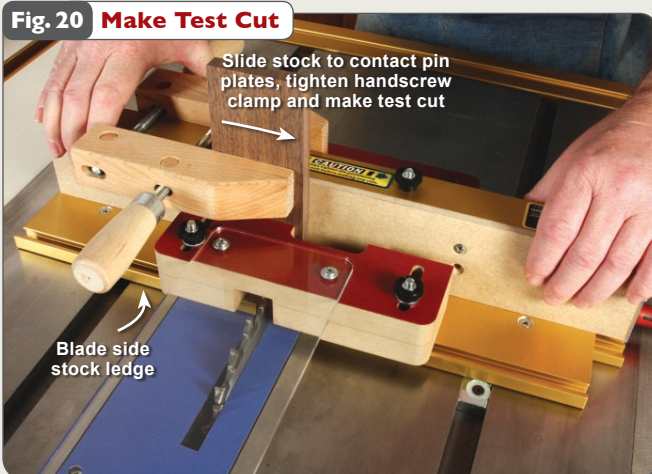
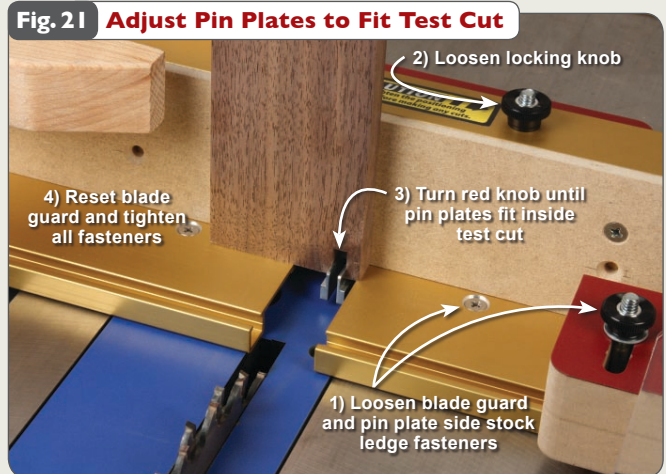

Fig. 21 Adjust Pin Plates to Fit Test Cut



GO...

NOTE: In the photos below, we have moved the blade guard aside after each cut for clarity. **DO NOT MAKE ANY CUTS WITHOUT FIRST POSITIONING AND SECURING THE BLADE GUARDS!**

1. First Cut - Front/Back Parts

If your box-making stock is a different thickness than the test cut stock you'll want to reset the blade guard as described in Step 5 on page 9, otherwise, place one of the boards on the blade side stock ledge between the fence and the blade guard and advance the marked edge up to contact the pin plates. Clamp the board with your wooden handscrew and make the cut, **Fig. 22**.

2. Step, Cut and Repeat - Front/Back Parts

Slide the IBOX clear of the cutter then unclamp and move the board to set the groove previously cut over the pin plates. Re-clamp and cut again, **Fig. 23**. Repeat this step until you have completed the cuts across the width of your board. Repeat steps 1-2 on the remaining ends of the first 2 boards.

3. Set Up - Side Parts

After cutting the final end of the first 2 boards, take one of them and set it on the **pin plate side stock ledge** with the marked edge facing the pin plates and advance it to set the first groove over the pin plates. Take one of the remaining 2 (uncut) boards and stand it on the **blade side stock ledge** and advance the marked edge to contact the marked edge on the first board. Clamp the board with your wooden handscrew, **Fig. 24**.

Fig. 22 First Cut - Front/Back Parts

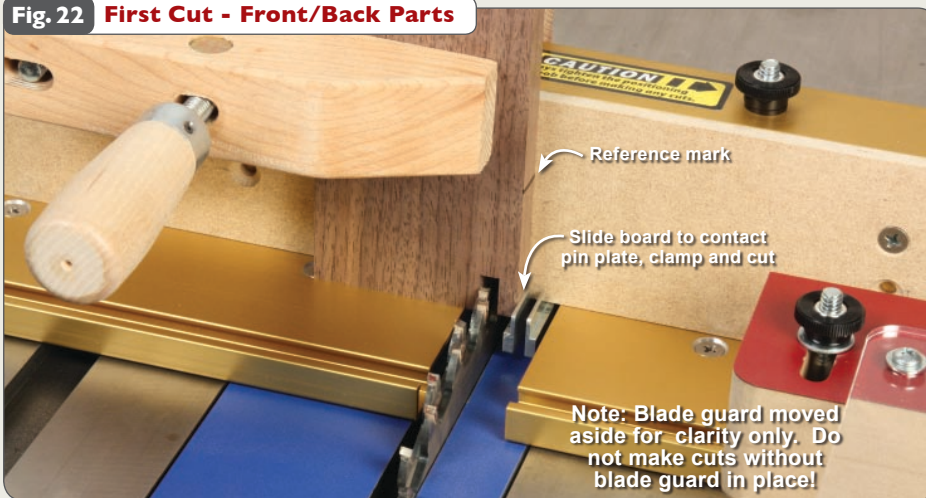
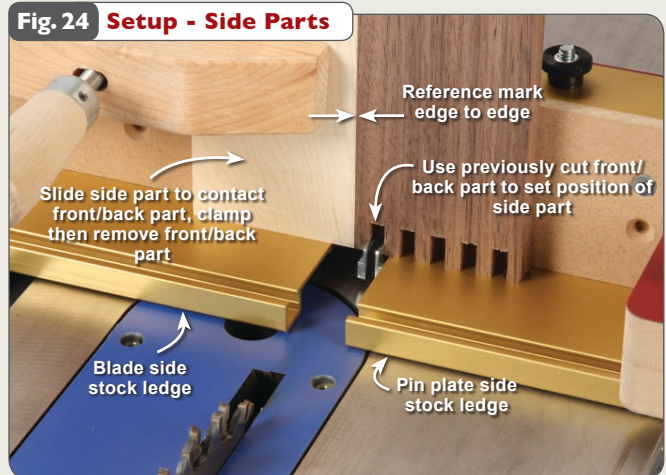

Fig. 23 Step, Cut and Repeat



Fig. 24 Setup - Side Parts



4. First Cut - Side Parts

Remove the previously cut board from the pin plate side stock ledge and set aside. Make the cut, **Fig. 25**.

5. Second Cut - Side Parts

Slide the IBOX clear of the cutter then unclamp and advance the board on the blade side stock ledge to contact the pin plates, clamp in place and make the cut, **Fig. 26**.

6. Step, Cut and Repeat - Side Parts

Slide the IBOX clear of the cutter then unclamp and

move the board to set the groove previously cut over the pin plates. Re-clamp and cut again, **Fig. 27**. Repeat this step until you have completed the cuts across the width of your board. Repeat steps 3-6 on the remaining ends of the final 2 boards.

7. Assemble

Assemble the box with all marked edges facing up, **Fig. 28**.

Fig. 25 First Cut - Side Parts

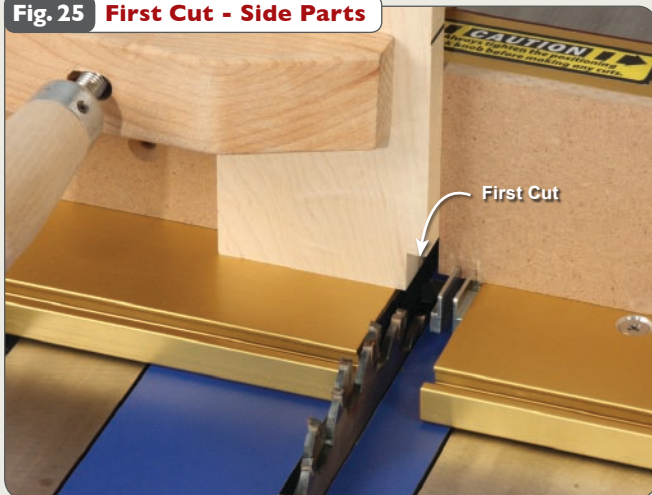

Fig. 26 Second Cut - Side Parts

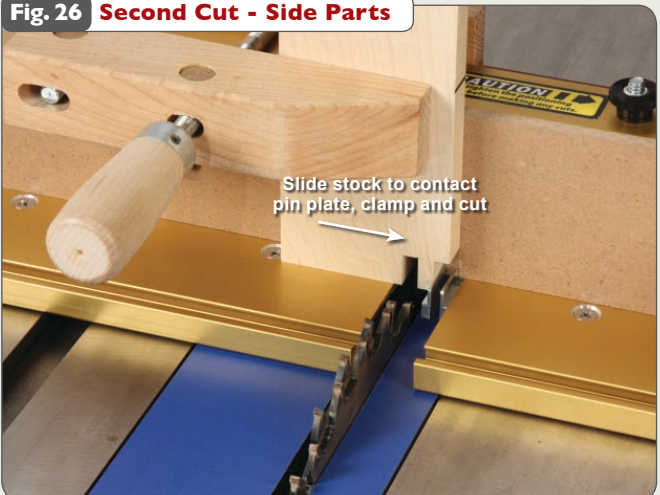

Fig. 27 Step, Cut and Repeat - Side Parts

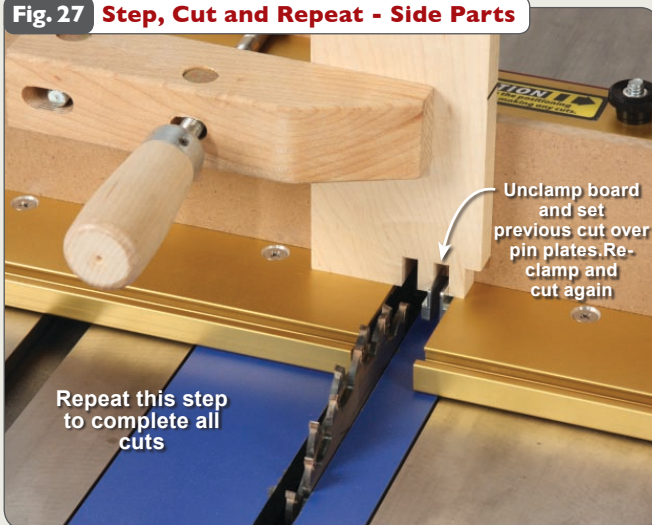
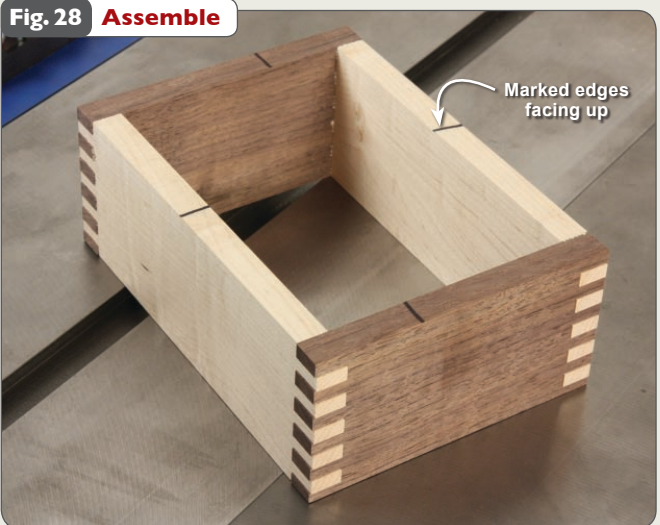

Fig. 28 Assemble



TIPS & TECHNIQUES

ADJUSTING THE FIT Fine adjustments to the fit of a joint can be made by loosening the positioning lock knob and holding the red knob as you rotate the silver micro-adjusting knob. Turning the silver knob clockwise makes the pin larger for a tighter fit, while turning the knob counterclockwise makes the pin smaller for a looser fit. (It may be helpful to remember the phrase, “Righty Tightly, Lefty Loosey”.) Use the laser cut slit on the silver knob and the engraved marks on the end of red knob to gauge movement, **Fig. 29**. Each mark represents .001” (one thousandth of an inch). After adjusting, always tighten the positioning lock knob located on top of the IBOX fence extrusion.

STOCK MARKING TIP Here’s a way to be sure that your wood is fully seated on the stock ledge before you begin each cut. Before cutting, stand each of your boards against the face of the fence and place a pencil mark across the board along the top of the fence, **Fig. 30**. That way, if the board is not fully seated, you’ll easily see it in comparing the mark to the top of the fence, **Fig. 31**.

CENTERED JOINERY In theory, just multiplying your cut width by an odd number should give you a board width that when cut will have an equal pin width on the outside edges of 2 of your boards. In practice it doesn’t work out quite that way. You need exact measurements of both the pin and groove width and a degree in higher math for the formula to work in your favor. Suffice it to say that it is easier just to make your stock 1/8” to 1/4” wider than the “Kerf x

Odd Number” formula and then trim off the excess after cutting the joints. If you are interested in a more creative approach to a centered joint, check out the “decorative techniques” in the included DVD.



WATCH THE INCLUDED DVD

There is no substitute for seeing it done. You’ll find these tips and many more as well as some new and interesting techniques for your New INCR A IBOX!

Fig. 29 Adjusting the Fit

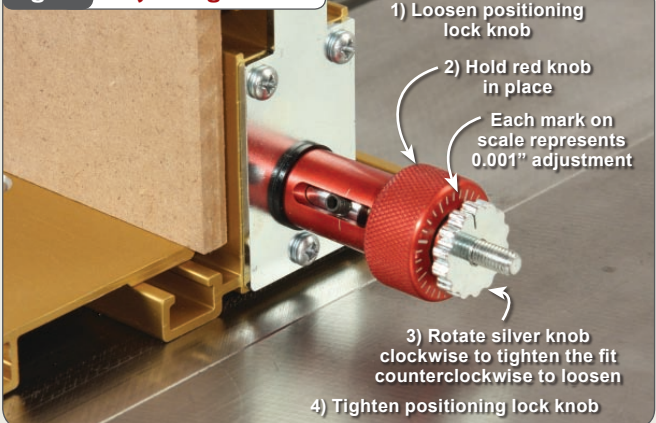

Fig. 30 Stock Marking Tip



Fig. 31 Don't Make That Cut



Manufactured by:
Taylor Design Group, Inc.
P.O. Box 810262 Dallas, TX 75381
www.incra.com

INCR A is a Registered Trademark of Taylor Design Group, Inc.
©2012 Taylor Design Group, Inc.

INCR A Tools are protected by one or more of the following US patents:
#4,793,604, #4,930,221, #5,195,730, #5,275,074, #5,423,360, #5,716,045, #6,237,457,
#6,557,601, #6,672,190. Other patents granted or pending. rev. 2.9.2012

